

CYLINDER VALVE OUTLET
RIGHT HAND
MALE

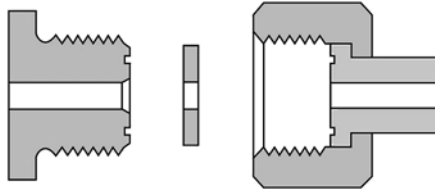

INLET CONNECTION
RIGHT HAND
FEMALE NUT, NIPPLE & GASKET

CONNECTION NO. 320

All dimensions are in inches - for reference only, subject to change.

CYLINDER VALVE OUTLET CAPS

PART NUMBER	DESCRIPTION	L
CAP-30BR-P	BRASS W/ POLY DISC LESS RING & CHAIN	0.54"
CAP-30BR-PR	BRASS W/ POLY DISC	0.54"
CAP-30BR-TCR	BRASS W/ TEFLON CALCIUM FILLED DISC	0.54"
CAP-30CH-PR	NICKEL PLATED BRASS W/ POLY DISC	0.54"
CAP-30SS-PR	303 STAINLESS STEEL W/ POLY DISC	0.54"
CAP-30SS-TCR	303 STAINLESS STEEL W/ TEFLON CALCIUM FILLED DISC	0.54"

DUST CAPS

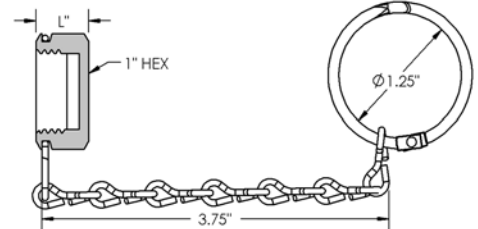

GASKETS

PART NUMBER	DESCRIPTION	D	H	W
GSK-32-T	VIRGIN PTFE	.703	.250	.094
GSK-32-K	VIRGIN PCTFE	.703	.250	.094

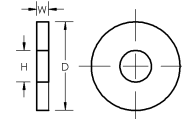

INLETS X 1/4" MALE NATIONAL PIPE THREAD (INCLUDES NUT, NIPPLE & PTFE GASKET)

PART NUMBER	DESCRIPTION	L
INL-320BR-4M-48	BRASS	3.00"
INL-CV320BR-4M	BRASS W/ CHECK VALVE	3.00"
INL-320CH-4M-48	NICKEL PLATED BRASS	3.00"
INL-CV320CH-4M	NICKEL PLATED BRASS W/ CHECK VALVE	3.00"
INL-320SS-4M-28	STAINLESS STEEL	1.75"
INL-320SS-4M-40	STAINLESS STEEL	2.50"
INL-320SS-4M-48	STAINLESS STEEL	3.00"
INL-320SS-4M-56	STAINLESS STEEL	3.50"
INL-320SS-4M-70R	STAINLESS STEEL W/ FILTER	4.375"
INL-CV320SS-4M	STAINLESS STEEL W/ CHECK VALVE	2.50"

BRASS OR NICKEL PLATED
BRASS NUT, NIPPLE &
GASKET

STAINLESS STEEL
303 NUT, 316L NIPPLE &
GASKET

OPTIONAL INTEGRAL
CHECK VALVE

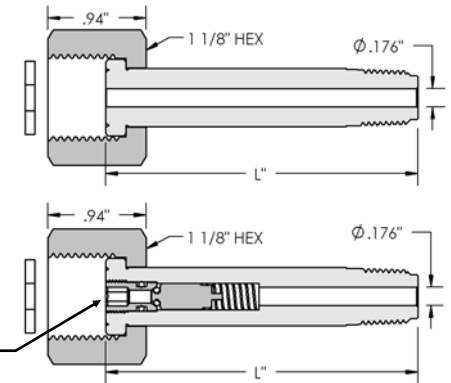

INLETS X 1/4" MALE FACE SEAL (INCLUDES 303 SS NUT, 316L SS NIPPLE & PCTFE GASKET)

PART NUMBER	DESCRIPTION	L
INL-320SS-4MFS-28	STAINLESS STEEL 12 Ra	1.75"
INL-320SS-4MFS-P	STAINLESS STEEL 9 Ra EP	1.75"

Available with Check Valve upon request

EP = Electropolished ID

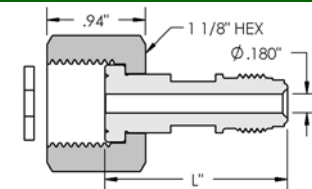

INLETS X ORBITAL TUBE WELD STUB (INCLUDES SILVER PLATED 303 SS NUT, 316L SS NIPPLE & PCTFE GASKET)

PART NUMBER	DESCRIPTION	L	T
INL-320SS-4TS-28F	STAINLESS STEEL 12 Ra*	1.75"	1/4" OD X .035" WALL
INL-320SS-4TS-P	STAINLESS STEEL 9 Ra EP*	1.75"	1/4" OD X .035" WALL
INL-CV320SS-4TS	STAINLESS STEEL W/ CHECK VALVE	2.47"	1/4" OD X .035" WALL
INL-320SS-6TS-30F	STAINLESS STEEL 12 Ra	1.875"	3/8" OD X .035" WALL
INL-320SS-6TS-P	STAINLESS STEEL 9 Ra EP	1.875"	3/8" OD X .035" WALL
INL-320SS-8TS-30F	STAINLESS STEEL 12 Ra	1.875"	1/2" OD X .049" WALL
INL-320SS-8TS-P	STAINLESS STEEL 9 Ra EP	1.875"	1/2" OD X .049" WALL

*PTH-7 Pigtail Handle available

EP = Electropolished ID

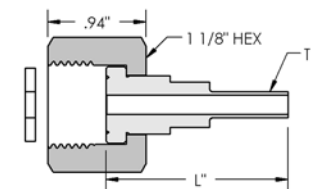

GasFlo Products Inc. CGA Compressed Gas Service Cylinder Connections are Manufactured to CGA V-1 Standards

Additional materials and configurations available on request. Minimum order quantities may be required.



MADE IN USA
CGA320-2017 Rev. A

40 Green Pond Road, Rockaway, NJ 07866 Phone: 973-276-9011 Fax: 973-276-9014 www.gasflo.com

Member Compressed Gas Association

COMPLETE PIGTAIL CONNECTION X ORBITAL TUBE WELD STUB (INCLUDES 303 SS NUT, 316L SS NIPPLE, 303 SS BLANK PLUG & PCTFE GASKET)

PART NUMBER	DESCRIPTION	L	T
PT-320SS-4TS-P	STAINLESS STEEL 9 Ra EP*	1.75"	1/4" OD x .035" WALL
PT-320SS-6TS-P	STAINLESS STEEL 9 Ra EP	1.875"	3/8" OD x .035" WALL
PT-320SS-8TS-P	STAINLESS STEEL 9 Ra EP	1.875"	1/2" OD x .049" WALL

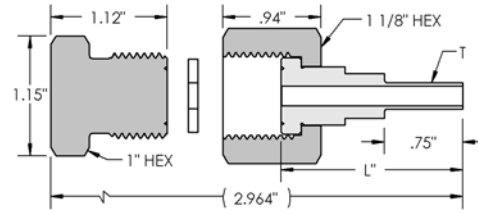

Blank plug available with ring & chain on request *PTH-7 Pigtail Handle available EP = Electropolished ID

COMPLETE PIGTAIL CONNECTION X 1/4 MALE FACE SEAL (INCLUDES 303 SS NUT, 316L NIPPLE, 303 SS BLANK PLUG & PCTFE GASKET)

PART NUMBER	DESCRIPTION	L
PT-320SS-4MFS-P	STAINLESS STEEL 9 Ra EP	1.75"

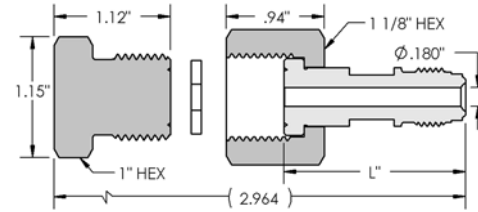

Blank plug available with ring & chain on request EP = Electropolished ID

INLET OPTIONS & ACCESSORIES

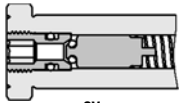

CV
W/ INTEGRAL CHECK VALVE

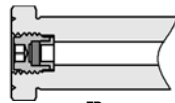

FR
W/ FLOW RESTRICTOR ORIFICE

PTH-7
PIGTAIL HANDLE SIZE 7 FOR USE ON 1/4" TUBE STUB INLETS ONLY

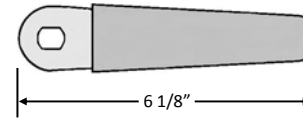

VALVE OUTLET ADAPTORS

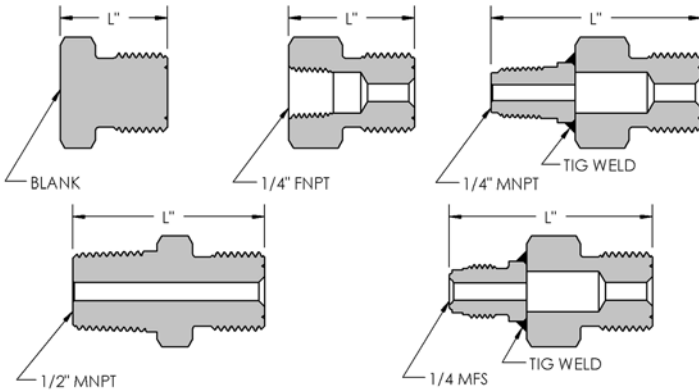

PART NUMBER	DESCRIPTION	L
AD-320MBR-4FNPT	BRASS 1/4" FNPT	1.31"
AD-320MBR-8MNPT	BRASS 1/2" MNPT	2.00"
AD-320MSS-BL	303 SS BLANK CAP	1.12"
AD-320MSS-4FNPT	316L SS 1/4" FNPT	1.31"
AD-320MSS-4MNPT	316L SS 1/4" MNPT	1.88"
AD-320MSS-8MNPT	316L SS 1/2" MNPT	2.00"
AD-320MSS-4MFS	316L SS 1/4 MALE FACE SEAL	1.88"

Blank cap available with ring & chain on request

3 PIECE ADAPTORS (INCLUDES 303 SS NUT, 316L SS NIPPLE & SS OUTLET ADAPTOR)

PART NUMBER	DESCRIPTION	L
AD-320F716M-SS	STAINLESS STEEL CGA 320 FEMALE X CGA 716 MALE	4.50"
AD-320F580F-SS	STAINLESS STEEL CGA 320 FEMALE X CGA 580 FEMALE	4.65"
AD-320F660M-SS	STAINLESS STEEL CGA 320 FEMALE X CGA 660 MALE	3.90"
AD-320FBS6M-SS	STAINLESS STEEL CGA 320 FEMALE X BS 6 MALE	3.75"
AD-320FD6M-SS	STAINLESS STEEL CGA 320 FEMALE X DIN 6 MALE	3.77"
AD-320FAFNORCM-SS	STAINLESS STEEL CGA 320 FEMALE X AFNOR C MALE	3.86"
AD-320FJ22RM-SS	STAINLESS STEEL CGA 320 FEMALE X JIS 22R MALE	3.96"

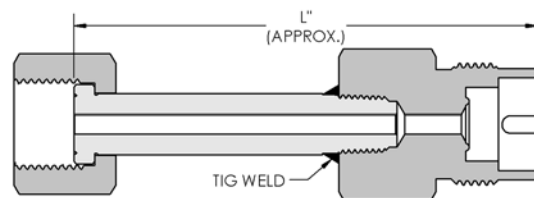

VALVE, FITTING OR OTHER COMPONENT FUNCTION, PROPER INSTALLATION, MATERIALS COMPATIBILITY, ADEQUATE RATINGS, OPERATION AND MAINTENANCE ARE THE RESPONSIBILITY OF THE SYSTEM DESIGNER AND USER.



PRODUCT FAILURE, IMPROPER SELECTION OR IMPROPER USE OF THE PRODUCTS AND/OR SYSTEMS DESCRIBED HEREIN OR RELATED ITEMS CAN CAUSE DEATH, PERSONAL INJURY AND PROPERTY DAMAGE.



MADE IN USA
CGA320-2017 Rev. A

GasFlo Products Inc. CGA Compressed Gas Service Cylinder Connections are Manufactured to CGA V-1 Standards
Additional materials and configurations available on request. Minimum order quantities may be required.

40 Green Pond Road, Rockaway, NJ 07866 Phone: 973-276-9011 Fax: 973-276-9014 www.gasflo.com

Member Compressed Gas Association



GASFLO PRODUCTS
©GasFlo Products, Inc. 2025