

CYLINDER VALVE OUTLET  
LEFT HAND  
MALE

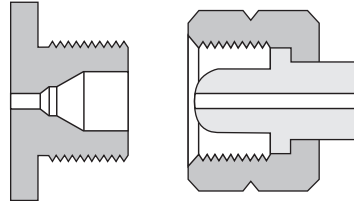

INLET CONNECTION  
LEFT HAND  
FEMALE NUT & NIPPLE

CONNECTION NO. 350

All dimensions are in inches - for reference only, subject to change.

CYLINDER VALVE OUTLET CAPS

PART NUMBER	DESCRIPTION	L
CAP-33BR-P	BRASS W/ POLY DISC LESS RING & CHAIN	0.54"
CAP-33BR-PR	BRASS W/ POLY DISC	0.54"
CAP-33BR-TCR	BRASS W/ TEFLON CALCIUM FILLED DISC	0.54"
CAP-33CH-PR	NICKEL PLATED BRASS W/ POLY DISC	0.54"
CAP-33SS-PR	303 STAINLESS STEEL W/ POLY DISC	0.54"
CAP-33SS-TCR	303 STAINLESS STEEL W/ TEFLON CALCIUM FILLED DISC	0.54"
CAP-GT350BR	BRASS GAS TIGHT LESS RING & CHAIN	0.75"
CAP-GT350BR-R	BRASS GAS TIGHT	0.75"
CAP-GT350BR-TV	BRASS GAS TIGHT W/ TEFLON O-RING	0.52"
CAP-GT350CH-R	NICKEL PLATED BRASS GAS TIGHT	0.75"
CAP-GT350SS-R	303 STAINLESS STEEL GAS TIGHT	0.75"
CAP-GT350SS-TV	303 STAINLESS STEEL GAS TIGHT W/ TEFLON O-RING	0.52"

DUST CAPS

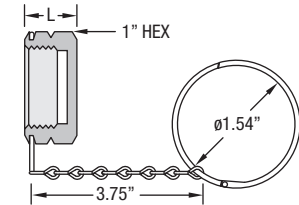

GAS TIGHT CAPS

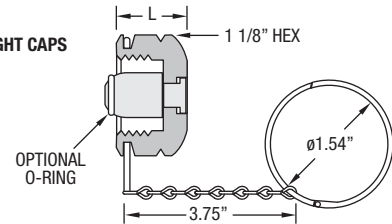

INLETS X 1/4" MALE NATIONAL PIPE THREAD (INCLUDES NUT & NIPPLE)

PART NUMBER	DESCRIPTION	L
INL-350BR-4M-48R	BRASS W/ FILTER	3.00"
INL-CV350BR-4M	BRASS W/ CHECK VALVE	3.00"
INL-350CH-4M-48R	NICKEL PLATED BRASS W/ FILTER	3.00"
INL-CV350CH-4M	NICKEL PLATED BRASS W/ CHECK VALVE	3.00"
INL-350SS-4M-36	STAINLESS STEEL	2.25"
INL-350SS-4M-48	STAINLESS STEEL	3.00"
INL-350SS-4M-48V	STAINLESS STEEL W/ VITON O-RING	3.00"
INL-350SS-4M-56	STAINLESS STEEL	3.50"
INL-350SS-4M-70R	STAINLESS STEEL W/ FILTER	4.375"
INL-CV350SS-4M	STAINLESS STEEL W/ CHECK VALVE	2.625"

BRASS OR NICKEL PLATED BRASS  
NUT & NIPPLE

PLATED SINTERED  
BRONZE FILTER  
STANDARD

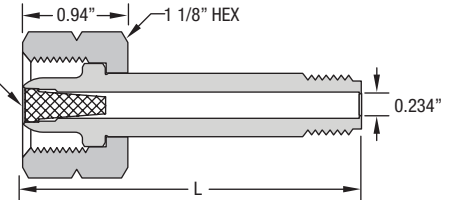

STAINLESS STEEL  
303 NUT & 316L NIPPLE

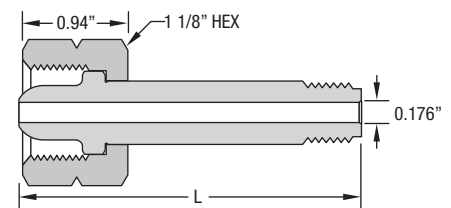

INLETS X 1/4 MALE FACE SEAL (INCLUDES 303 SS NUT & 316L SS NIPPLE)

PART NUMBER	DESCRIPTION	L
INL-350SS-4MFS-36	STAINLESS STEEL 12 Ra	2.25"
INL-350SS-4MFS-P	STAINLESS STEEL 9 Ra EP	2.25"

Available with Check Valve upon request

EP = Electropolished ID

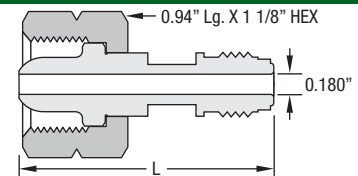

INLETS X ORBITAL TUBE WELD STUB (INCLUDES SILVER PLATED 303 SS NUT & 316L SS NIPPLE)

PART NUMBER	DESCRIPTION	L	T
INL-350SS-4TS-37F	STAINLESS STEEL 12 Ra *	2.31"	1/4" OD x .035" WALL
INL-350SS-4TS-P	STAINLESS STEEL 9 Ra EP *	2.31"	1/4" OD x .035" WALL
INL-CV350SS-4TS	STAINLESS STEEL W/ CHECK VALVE	2.34"	1/4" OD x .035" WALL
INL-350SS-6TS	STAINLESS STEEL 12 Ra	2.31"	3/8" OD x .035" WALL
INL-350SS-6TS-P	STAINLESS STEEL 9 Ra EP	2.31"	3/8" OD x .035" WALL
INL-350SS-8TS	STAINLESS STEEL 12 Ra	2.31"	1/2" OD x .049" WALL
INL-350SS-8TS-P	STAINLESS STEEL 9 Ra EP	2.31"	1/2" OD x .049" WALL

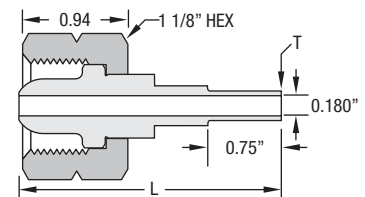

\*PTH-7 Pigtail Handle available

EP = Electropolished ID



MADE IN USA

GasFlo Products Inc. CGA Compressed Gas Service Cylinder Connections are Manufactured to CGA V-1 Standards  
Additional materials and configurations available on request. Minimum order quantities may be required.

40 Green Pond Road, Rockaway, NJ 07866 Phone: 973-276-9011 Fax: 973-276-9014 www.gasflo.com



GASFLOPRODUCTS

**COMPLETE PIGTAIL CONNECTION X ORBITAL TUBE WELD STUB (INCLUDES SILVER PLATED 303 SS NUT, 316L SS NIPPLE & 303 SS BLANK PLUG)**

PART NUMBER	DESCRIPTION	L	T
PT-350SS-4TS-P	STAINLESS STEEL 9 Ra EP **	2.31"	1/4" OD x .035" WALL
PT-350SS-4TS-VF-P	SS W/ VITON O-RING 9 Ra EP *	2.31"	1/4" OD x .035" WALL
PT-350SS-6TS-P	STAINLESS STEEL 9 Ra EP	2.31"	3/8" OD x .035" WALL
PT-350SS-8TS-P	STAINLESS STEEL 9 Ra EP	2.31"	1/2" OD x .049" WALL

\*Blank cap available with ring & chain on request    \*\*PTH-7 Pigtail Handle available    EP = Electropolished ID

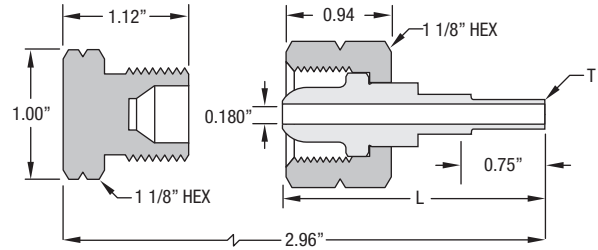

**COMPLETE PIGTAIL CONNECTION X 1/4 MALE FACE SEAL (INCLUDES 303 SS NUT, 316L SS NIPPLE & 303 SS BLANK PLUG)**

PART NUMBER	DESCRIPTION	L	T
PT-350SS-4MFS-P	STAINLESS STEEL 9 Ra EP †	2.25"	1/4 MALE FACE SEAL

\*Blank cap available with ring & chain on request    EP = Electropolished ID

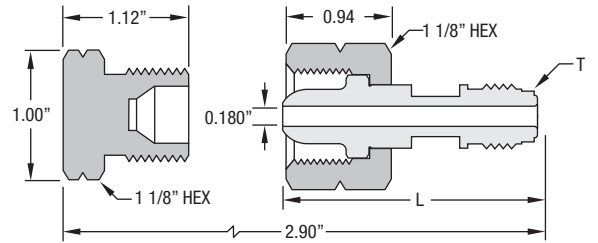

**INLET OPTIONS & ACCESSORIES**

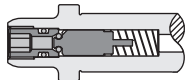

**CV**  
W/ INTEGRAL CHECK VALVE

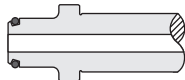

**V**  
W/ VITON O-RING

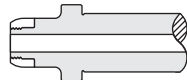

**Q**  
W/ SOFT PCTFE TIP

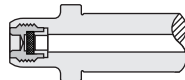

**FR**  
W/ FLOW RESTRICTOR ORIFICE

**PTH-7**  
\*PIGTAIL HANDLE  
SIZE 7  
FOR USE ON  
1/4" TUBE STUB  
INLETS ONLY



6 1/8"

**VALVE OUTLET ADAPTORS**

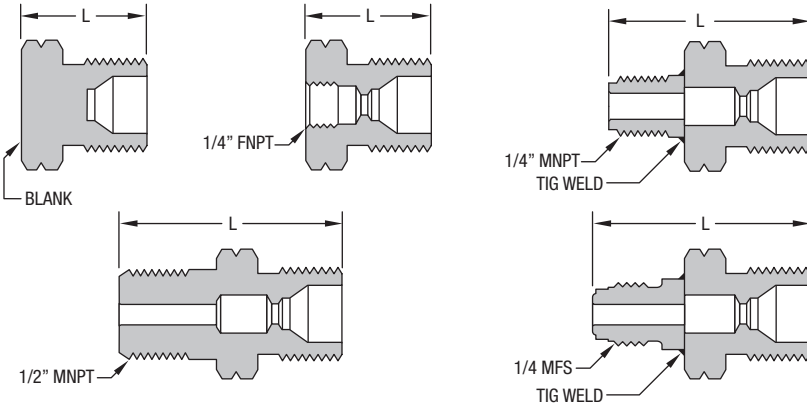

PART NUMBER	DESCRIPTION	L
AD-350MBR-4FNPT	BRASS 1/4" FNPT	1.31"
AD-350MBR-4MNPT	BRASS 1/4" MNPT	1.88"
AD-350MBR-8MNPT	BRASS 1/2" MNPT	2.00"
AD-350MSS-BL	303 SS BLANK CAP†	1.12"
AD-350MSS-4FNPT	316L SS 1/4" FNPT	1.31"
AD-350MSS-4MNPT	316L SS 1/4" MNPT	1.88"
AD-350MSS-8MNPT	316L SS 1/2" MNPT	2.00"
AD-350MSS-4MFS	316L SS 1/4 MALE FACE SEAL	2.13"

†Blank cap available with ring & chain on request

**3 PIECE ADAPTORS (INCLUDES 303 SS NUT, 316L SS NIPPLE & SS OUTLET ADAPTOR)**

PART NUMBER	DESCRIPTION	L
AD-350F632M-SS	STAINLESS STEEL CGA 350 FEMALE X CGA 632 MALE	4.50"
AD-350F724M-SS	STAINLESS STEEL CGA 350 FEMALE X CGA 724 MALE	4.50"
AD-350FBS4F-SS	STAINLESS STEEL CGA 350 FEMALE X BS 4 FEMALE	3.75"
AD-350FD1M-SS	STAINLESS STEEL CGA 350 FEMALE X DIN 1 MALE	3.75"
AD-350FD5M-SS	STAINLESS STEEL CGA 350 FEMALE X DIN 5 MALE	3.75"
AD-350FAFNOREM-SS	STAINLESS STEEL CGA 350 FEMALE X AFNOR E MALE	3.75"
AD-350FJ22LM-SS	STAINLESS STEEL CGA 350 FEMALE X JIS 22L MALE	3.75"

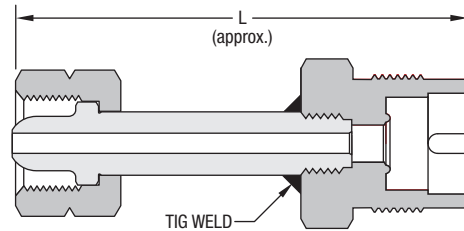

VALVE, FITTING OR OTHER COMPONENT FUNCTION, PROPER INSTALLATION, MATERIALS COMPATIBILITY, ADEQUATE RATINGS, OPERATION AND MAINTENANCE ARE THE RESPONSIBILITY OF THE SYSTEM DESIGNER AND USER.



PRODUCT FAILURE, IMPROPER SELECTION OR IMPROPER USE OF THE PRODUCTS AND/OR SYSTEMS DESCRIBED HEREIN OR RELATED ITEMS CAN CAUSE DEATH, PERSONAL INJURY AND PROPERTY DAMAGE.



**GasFlo Products Inc. CGA Compressed Gas Service Cylinder Connections are Manufactured to CGA V-1 Standards**  
Additional materials and configurations available on request. Minimum order quantities may be required.

**40 Green Pond Road, Rockaway, NJ 07866 Phone: 973-276-9011 Fax: 973-276-9014 www.gasflo.com**

